

GN22-12(C) Indoor AC High Voltage Disconnect Switch

Summary

GN22-12(C) disconnect switch is an indoor electric apparatus of rated voltage 12kV three-phase AC 50/60Hz. it is used to break, make and transfer lines when the HV apparatus is under situations with voltage and no-load. It is manufactured according to IEC62271-102.



Ambient condition

1. Altitude: $\leq 1000\text{m}$;
2. Ambient temperature: $-30^{\circ}\text{C}\sim+40^{\circ}\text{C}$;
3. Relative humidity: daily average $\leq 95\%$, monthly average $\leq 90\%$;
4. Earthquake intensity: ≤ 8 degree;
5. Applicable occasions should free from inflammables, explosives, corrosives and severe vibration.

Model

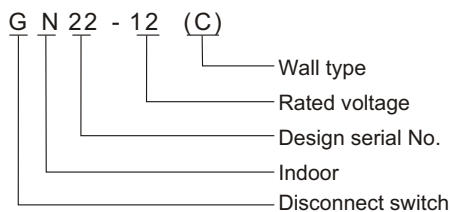

Product feature

1. Scientific and reliable design.
2. Large current capacity.
3. Easy maintenance and operation.

Technical specification

Item		Unit	Data	
Rated voltage		kV	12	
Rated frequency		Hz	50/60	
Rated current		A	1600-2000	2500-3150
Rated short-time withstand current		kA	40	50
Rated peak withstand current		kA	100	125
Rated short-circuit duration		s	4	
Rated insulating level	1min. PF withstand voltage	kV	phase to phase/ to earth: 42, across open contacts: 49	
	Lightning impulse withstand voltage(peak)	kV	phase to phase/ to earth: 75, across open contacts: 85	

Outline dimension

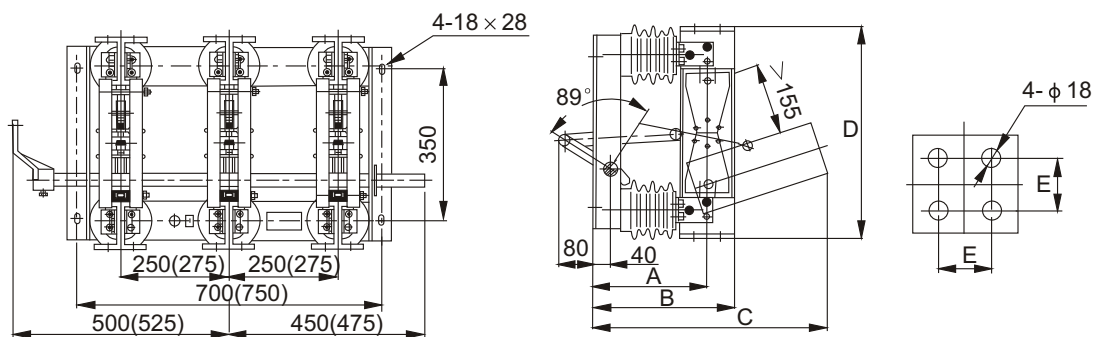

Diagram 1 GN22-12

Model	A	B	C	D	E
GN22-12/1600-2000	255	305	527	490	50
GN22-12/2500-3150	262	325	538	494	60

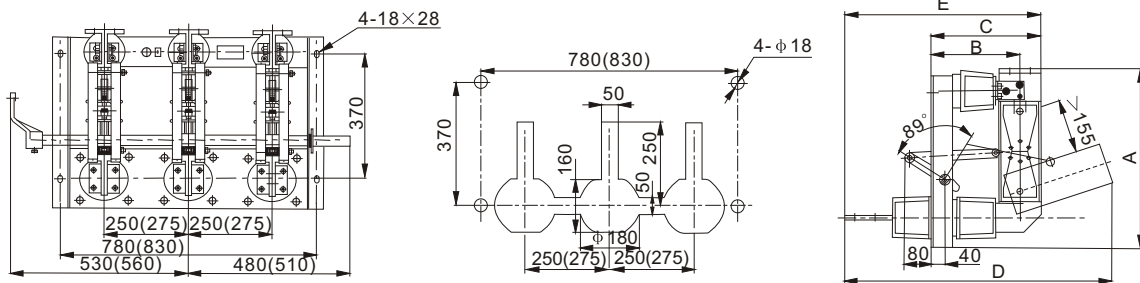
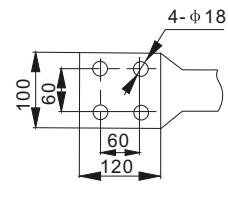
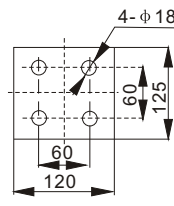
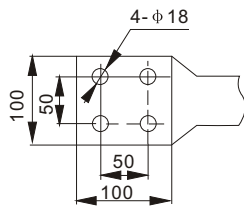
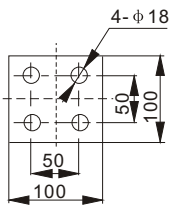

Diagram 2 GN22-12C



GN22-12C/1600~2000 Connection terminal

GN22-12C/2500~3150 Connection terminal

Model	A	B	C	D	E
GN22-12C/1600~2000	537	255	305	807	580
GN22-12C/2500~3150	539	267.5	330	880	630